



# Grandstream Networks, Inc.

---

## GXP Series SIP Enterprise Phones IP Phone



## TABLE OF CONTENTS GXP USER MANUAL

<b>WELCOME .....</b>	<b>4</b>
<b>INSTALLATION.....</b>	<b>5</b>
EQUIPMENT PACKAGING .....	5
CONNECTING YOUR PHONE .....	5
GXP-2000 EXTENSION UNIT.....	5
SAFETY COMPLIANCES.....	7
WARRANTY.....	7
<b>PRODUCT OVERVIEW.....</b>	<b>8</b>
<b>USING THE GXP SIP ENTERPRISE PHONE.....</b>	<b>12</b>
GETTING FAMILIAR WITH THE LCD .....	12
MAKING PHONE CALLS.....	16
ANSWERING PHONE CALLS .....	19
PHONE FUNCTIONS DURING A PHONE CALL .....	19
CALL FEATURES.....	21
CUSTOMIZED LCD SCREEN & XML .....	21
<b>CONFIGURATION GUIDE .....</b>	<b>22</b>
CONFIGURATION VIA KEYPAD.....	22
CONFIGURATION VIA WEB BROWSER .....	25
SAVING THE CONFIGURATION CHANGES.....	37
REBOOTING THE PHONE REMOTELY .....	37
<b>SOFTWARE UPGRADE &amp; CUSTOMIZATION.....</b>	<b>38</b>
FIRMWARE UPGRADE THROUGH TFTP/HTTP .....	38
CONFIGURATION FILE DOWNLOAD .....	39
<b>RESTORE FACTORY DEFAULT SETTING.....</b>	<b>40</b>

## TABLE OF FIGURES GXP USER MANUAL

Figure 1: Connecting the GXP–2000 and the GXP–Extension .....	6
Figure 2: GXP–2000 Internal Headset Wiring Schema .....	7
Figure 3: Key Pad GUI Call Flow .....	44

## TABLE OF TABLES GXP USER MANUAL

Table 1: Equipment Packaging .....	5
Table 2: GXP Connectors .....	5
Table 3: GXP Product Models .....	8
Table 4: GXP Comparison Guide .....	9
Table 5: GXP Key Features in a Glance.....	9
Table 6: GXP Hardware Specifications.....	9
Table 7: GXP Technical Specifications.....	10

Table 8: LCD Buttons .....	12
Table 9: LCD Icons .....	13
Table 10: GXP Keypad Buttons .....	14
Table 11: GXP Call Features .....	21
Table 12: Key Pad Configuration Menu .....	42
Table 13: Device Configuration - Status .....	46
Table 14: Device Configuration – Basic Settings.....	46
Table 15: Advanced Settings .....	48
Table 16: SIP Account Settings .....	53

## GUI INTERFACE EXAMPLES

### GXP USER MANUAL

[http://www.grandstream.com/support/gxp\\_series/general/documents/gxp\\_gui.zip](http://www.grandstream.com/support/gxp_series/general/documents/gxp_gui.zip)

1. SCREENSHOT OF CONFIGURATION LOGIN PAGE
2. SCREENSHOT OF STATUS PAGE
3. SCREENSHOT OF BASIC SETTINGS CONFIGURATION PAGE
4. SCREENSHOT OF ADVANCED USER CONFIGURATION PAGE
5. SCREENSHOT OF SIP ACCOUNT CONFIGURATION
6. SCREENSHOT OF SAVED CONFIGURATION CHANGES
7. SCREENSHOT OF REBOOT PAGE

## Welcome

Your Grandstream GXP Series IP phone features a new sophisticated design and is very easy to use. The GXP combines advanced feature functionality with the latest technology to offer excellent audio quality, ease of use, expandability, and broad interoperability with 3<sup>rd</sup> party SIP platforms. It is ideal for the enterprise customer.

The GXP Series supports a broad range of codecs, security protection, PoE (except on GXP-280), dual 10/100Mbps Ethernet ports and are very easy to manage. Currently, the GXP Series consists of the following five models: GXP-280, GXP-1200, GXP-2000, GXP-2010 and GXP-2020. Each model delivers superior audio quality using either a handset, hands-free speakerphone or headset (except for GXP2000) and supports multi-party conferencing, multi-languages, dual-color LEDs, presence and BLF (on most models). Large easy-to-read backlit graphical displays (except GXP-280) with multiple XML keys further enhance the user experience. Some models (GXP-2000, GXP2010 and GXP2020 currently) are expandable with one or two expansion module.

The series is based on SIP standard and are interoperable with most 3rd party SIP platforms and open-source platforms.

**Caution:** *Changes or modifications to this product not expressly approved by Grandstream, or operation of this product in any way other than as detailed by this User Manual, could void your manufacturer warranty.*

**Warning:** *Please do not use a different power adaptor with the GXP as it may cause damage to the products and void the manufacturer warranty.*

- This document is contains links to Grandstream GUI Interfaces. Please download these examples from [http://www.grandstream.com/support/gxp\\_series/general/documents/gxp\\_gui.zip](http://www.grandstream.com/support/gxp_series/general/documents/gxp_gui.zip) for your reference.
- This document is subject to change without notice. The latest electronic version of this user manual is available for download @:  
[http://www.grandstream.com/support/gxp\\_series/general/documents/gxp\\_usermanual\\_english.pdf](http://www.grandstream.com/support/gxp_series/general/documents/gxp_usermanual_english.pdf)
- *Reproduction or transmittal of the entire or any part, in any form or by any means, electronic or print, for any purpose without the express written permission of Grandstream Networks, Inc. is not permitted.*

## Installation

### EQUIPMENT PACKAGING

**Table 1: Equipment Packaging**

	<b>GXP-280</b>	<b>GXP-1200</b>	<b>GXP-2000</b>	<b>GXP-2010</b>	<b>GXP-2020</b>
<b>Main Case</b>	Yes	Yes	Yes	Yes	Yes
<b>Handset</b>	Yes	Yes	Yes	Yes	Yes
<b>Phone Cord</b>	Yes	Yes	Yes	Yes	Yes
<b>Power Adaptor</b>	Yes	Yes	Yes	Yes	Yes
<b>Ethernet Cable</b>	Yes	Yes	Yes	Yes	Yes
<b>High Phone Stand</b>	No	Yes	No	Yes	Yes
<b>Low Phone Stand</b>	Yes	No	No	Yes	Yes
<b>Wall Mount Spacers (2)</b>	No	Yes	No	Yes	Yes

### CONNECTING YOUR PHONE

The connectors of the GXP1200/2010/2020 are located on the bottom of the device while they are located on the back side of the GXP280/2000.

**Table 2: GXP Connectors**

<b>EXT</b>	Connects the GXP Extension unit directly to the GXP using connection cable. Draws power from PoE if provided by network.
<b>PC</b>	10/100Mbps RJ-45 ports for PC (downlink) connection.
<b>LAN</b>	10/100Mbps RJ-45 port for LAN (uplink) connection. Supports PoE (802.3af). Draws power from either spare line or signal line.
<b>Power Jack</b>	5V DC power port; UL Certified
<b>Headset Jack</b>	RJ22 and 2.5mm for GXP-280/2010/2020 RJ22 for GXP-1200 2.5mm for GXP-2000 HW Rev1.0 or later
<b>Handset Jack</b>	RJ11

### GXP-2000 EXTENSION UNIT

GXP-2000 supports two (2) extension units, providing up to 112 additional programmable extensions. Each GXP Extension unit has 56 multi-purpose keys, dual color LEDs (red/green) and support BLF (Busy Lamp Field) and Presence.

GXP-2000 Extension package contains:

- 1) One GXP Extension unit
- 2) One PS2 cable
- 3) One connection plate
- 4) One Universal Power Adaptor

**FIGURE 1: CONNECTING THE GXP-2000 AND THE GXP-EXTENSION**

**GXP-2000 w/GXP-Extension**



**Connecting the GXP-2000  
w/GXP-Extension**



**GXP Extension**

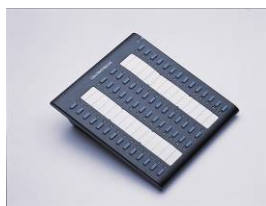

**Reverse side of connection  
w/connection plate**



Connect the first GXP -EXT to the GXP-2000 using the PS2 cable found in the GXP Extension package. The first GXP-Ext draws power directly from the phone. Connect the second GXP Extension unit using the connection plate and the PS2 cable. The GXP2000 will automatically reboot and power up the GXP Extensions. Grandstream recommends, though not required, to use a separate power supply with the second GXP Ext.

**NOTE:** should your system lose power, please unplug your devices and power up the GXP-2000 first.

Powering up the system:

1. The GXP-2000 will boot up first;
2. The GXP LEDs will be solid red;
3. The status light in the top right corner of the GXP-Ext will blink red;
4. All of the LED indicators on the GXP-Ext will flash three times;
5. The status light at the top right corner of the GXP-Ext will turn to solid green.

**NOTE:** 1. Extension for GXP2010 and GXP2020 does not support hot-swap. Once connected, user should reboot the phone to ensure the set up will work correctly.

2. GXP2010/GXP2020 can drive 2 extension modules. Independent power adapters are not needed for extension modules.

**Figure 2: GXP-2000 Internal Headset Wiring Schema**

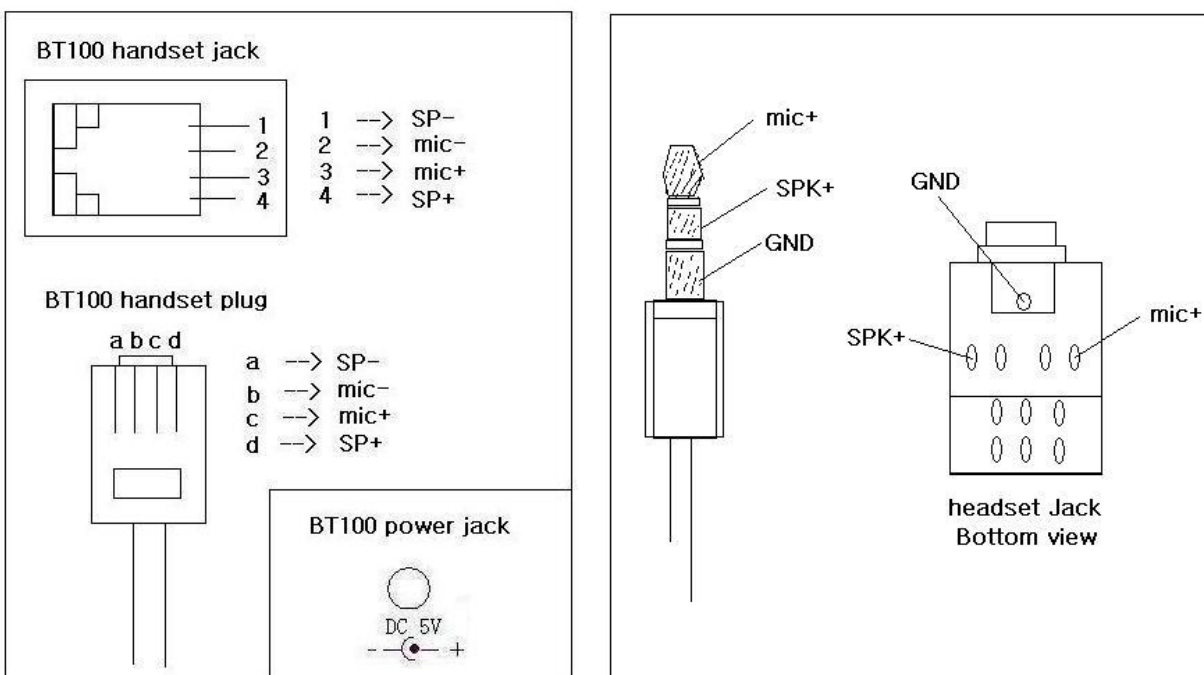

**NOTE:** For GXP-2000 HW REV. 0.3 and 0.4, a 3.5mm to 2.5mm plug converter is required to use a 2.5mm headset. The converter can be purchased at any electronics store.

## SAFETY COMPLIANCES





The GXP phone complies with FCC/CE and various safety standards. The GXP power adaptor is compliant with the UL standard. Only use the universal power adaptor provided with the GXP package. The manufacturer's warranty does not cover damages to the phone caused by unsupported power adaptors.

## WARRANTY

If you purchased your GXP from a reseller, please contact the company where you purchased your phone for replacement, repair or refund. If you purchased the product directly from Grandstream, contact your Grandstream Sales and Service Representative for a RMA (Return Materials Authorization) number before you return the product. Grandstream reserves the right to remedy warranty policy without prior notification.

## Product Overview

Table 3: GXP Product Models

Model	Picture	Overview
GXP-280		GXP280 is an entry-level SIP phone. It features: <ul style="list-style-type: none"> <li>• Single line</li> <li>• Three soft keys</li> </ul>
GXP-1200		GXP1200 is an entry-level SIP phone. It features: <ul style="list-style-type: none"> <li>• Two lines</li> <li>• Three soft keys</li> </ul>
GXP-2000		GXP2000 is a mainstream SIP phone. It features: <ul style="list-style-type: none"> <li>• Four lines</li> <li>• Seven programmable hard keys</li> </ul>
GXP-2010		GXP2010 is a key system SIP phone. It features: <ul style="list-style-type: none"> <li>• Four lines</li> <li>• Eighteen programmable hard keys</li> <li>• Three XML programmable soft keys</li> </ul>
GXP-2020		GXP2020 is an executive SIP phone. It features: <ul style="list-style-type: none"> <li>• Six lines</li> <li>• Seven programmable hard keys</li> <li>• Four XML programmable soft keys</li> </ul>



**Table 4: GXP Comparison Guide**

Features	GXP-280	GXP-1200	GXP-2000	GXP-2010	GXP-2020
LCD Display	128x32 pixel	128x32 pixel	130x64 pixel	240x120 pixel	320x160 pixel
Number of Lines	1	2	4	4	6
Programmable Hard Keys	No	No	7	18	7
Soft Keys	3	3	No	3	4
Extension Module	No	No	Yes, up to 2 Expansion Modules, 56 nodes each	Yes, up to 2 Expansion Modules, 56 nodes each	Yes, up to 2 Expansion Modules, 56 nodes each

**Table 5: GXP Key Features in a Glance**

Features	Benefits
Open Standards Compatible	SIP 2.0, TCP/IP/UDP, RTP/RTCP, HTTP/HTTPS, ARP/RARP, ICMP, DNS (A record and SRV), DHCP (both client and server), PPPoE, TFTP, NTP, Telnet, and TLS (pending).
Superb Audio Quality	Advanced Digital Signal Processing (DSP), Silence suppression, VAD, CNG, AGC.
Network Interfaces	Dual 10/100mbps Ethernet ports, headset jack (RJ22 and/or 2.5mm jack).
Feature Rich	Traditional voice features including caller ID, call waiting, hold, transfer, forward, block, autodial, off-hook dial, and click to dial.
Advanced Features	Multi-line support with dual-color LED (except on GXP-280), multi-party conferencing, line extension interface, large back-lit (except on GXP-280) graphic LCD, 5 or 3 navigation keys, dedicated buttons for hold, send, speakerphone, headset, transfer, conference (for up to 5 parties depending on model), mute, message, Do-not-disturb, phone book, intercom/paging.
Advanced Functionality	Custom down-loadable ring-tones, SRTP, SIP over TLS (pending), multi-language support and XML enabled, adjustable positioning angles, wall mountable, AES encryption.

**Table 6: GXP Hardware Specifications**

LAN Interface (Ethernet ports)	Two (2) 10/100 Mbps Full/Half Duplex Ethernet Switch with LAN and PC port with auto detection				
Graphic LCD Display	GXP-280	GXP-1200	GXP-2000	GXP-2010	GXP-2020
	128x32 pixel	128x32 pixel	130x64 pixel	240x120 pixel	320x160 pixel
Expansion Module Support	GXP-280	GXP-1200	GXP-2000	GXP-2010	GXP-2020
	No	No	Yes	Yes	Yes
Headset Jack					

	GXP-280	GXP-1200	GXP-2000	GXP-2010	GXP-2020
	2.5mm and RJ22	RJ22	2.5mm	2.5mm and RJ22	2.5mm and RJ22
<b>Call Appearance LED</b>	Dual color (green/red)				
	GXP-280	GXP-1200	GXP-2000	GXP-2010	GXP-2020
	No	3	11	22	13
<b>Power over Ethernet</b>	Built-in auto-sensing: Cisco and IEEE 802.3af standard: phone draws power from both spare lines or signal lines from Ethernet (except on GXP-280)				
<b>Universal Switching</b>	Input: 100-240VAC 50-60 Hz				
<b>Power Adaptor</b>	Output: +5VDC, 1200mA, <b>UL</b> certified				
<b>Dimension</b>					
	GXP-280	168mm(l) x 200mm(w) x 89.5mm(h)			
	GXP-1200	210mm(l) x 195mm(w) x 77mm(h)			
	GXP-2000	220mm(l) x 215mm(w) x 57mm(h)			
	GXP-2010	210mm(l) x 250mm(w) x 77mm (h)			
	GXP-2020	251mm(l) x 202mm(w) x 77mm(h)			
<b>Weight</b>					
	GXP-280	GXP-1200	GXP-2000	GXP-2010	GXP-2020
	0.62kg (1.37lbs)	0.86kg (1.91lbs)	0.82kg (1.81lbs)	1.1kg (2.44lbs)	1.66kg (3.64lbs)
<b>Temperature</b>	32 –104 °F / 0 – 40 °C				
<b>Humidity</b>	10% – 90% (non-condensing)				
<b>Compliance</b>	FCC / CE / C-Tick				

**Table 7: GXP Technical Specifications**

<b>Lines</b>	Multiple direct lines with independent SIP accounts, programmable speed dial keys, XML programmable soft-keys (non programmable on GXP-280, GXP1200).				
<b>Protocol Support</b>	Support SIP 2.0, TCP/UDP/IP, PPPoE, RTP/RTCP, SRTP by SDPES, HTTP, ARP/RARP, ICMP, DNS, DHCP, NTP, TFTP, SIMPLE/PRESENCE protocols Support multiple SIP accounts and up to 11 media channels concurrently Support SIP PUBLISH method (RFC 3903), SIP Presence package (RFC 3856, 3863) for use of 7 MFks, SIP Dialog package (RFC 4235) Support for SIP MESSAGE method (RFC 3428) Stores up to 100 incoming IM messages (drops IM message 101 plus)				
<b>Display</b>	Back-lit graphic LCD display. (GXP-280 display is not back-lit)				
<b>Feature Keys</b>					
	GXP-280	GXP-1200	GXP-2000	GXP-2010	GXP-2020
HOLD	Yes	Yes	Yes	Yes	Yes

	SPEAKERPHONE	Yes	Yes	Yes	Yes	Yes
	SEND	Yes	Yes	Yes	Yes	Yes
	TRANSFER	Yes	Yes	Yes	Yes	Yes
	CONF	Yes	Yes	Yes	Yes	Yes
	MUTE	Yes	Yes	Yes	Yes	Yes
	DND	Yes	Yes	Yes	Yes	Yes
	HEADSET	Yes	Yes	Yes	Yes	Yes
	INTERCOM	No	No	No	Yes	Yes
	PHONEBOOK	No	No	No	Yes	Yes
	MSG	Yes	Yes	Yes	Yes	Yes
	MENU	Yes	Yes	Yes	Yes	Yes
	NAVIGATION (4)	Yes (3)	Yes	Yes	Yes	Yes
<b>Device Management</b>	<p>NAT-friendly remote software upgrade (via TFTP/HTTP) for deployed devices including behind firewall/NAT</p> <p>Auto/manual provisioning system, GUI Interface</p> <p>Support Layer 2 (802.1Q, VLAN, 802.1p) and Layer 3 QoS (ToS, DiffServ, MPLS)</p> <p>Expansion interface, Address Book</p>					
<b>Audio Features</b>	<p>Full-duplex hands-free speakerphone, headset enabled</p> <p>Advanced Digital Signal Processing (DSP)</p> <p>Dynamic negotiation of codec and voice payload length</p> <p>Support for G.723,1 (5.3/6.3K), G.729A/B, G.711 a/μ-law, G.726-32, G.722 (wide-band), GSM and iLBC codecs</p> <p>In-band and out-of-band DTMF (in audio, RFC2833, SIP INFO)</p> <p>Silence Suppression, VAD (voice activity detection), CNG (comfort noise generation), ANG (automatic gain control)</p> <p>Acoustic Echo Cancellation (AEC) with Acoustic Gain Control (AGC) for speakerphone mode, Support side tone</p> <p>Adaptive jitter buffer control (patent-pending) and packet delay &amp; loss concealment</p>					
<b>Telephony Features</b>	<p>Intuitive graphic user interface (GUI), downloadable phone book (XML, LDAP), support for anonymous call using privacy header, MLS (multi language support)</p> <p>Voice mail indicator, downloadable custom ring-tones, call hold, call transfer (attended/blind), call forward, call waiting, caller ID, mute, redial, call log, caller ID display or block, Do-Not-Disturb (DND) and volume control</p> <p>Multi-party conferencing (up to 5), dial plan prefix, off-hook auto dial, auto answer, early dial and speed dial (on some models)</p>					
<b>Network and Provisioning</b>	<p>Via keypad/LCD, Web browser, or secure (AES encrypted) central configuration file, manual or dynamic host configuration protocol (DHCP) network setup</p> <p>Support NAT traversal using IETF STUN and Symmetric RTP</p> <p>Support for IEEE 802.1p/Q tagging (VLAN), Layer 3 TOS</p>					
<b>Firmware Upgrades</b>	<p>Support firmware upgrade via TFTP or HTTP,</p> <p>Support for Authenticating configuration file before accepting changes</p> <p>User specific URL for configuration file and firmware files</p>					
<b>Advanced Server Features</b>	<p>Message waiting indication, support DNS SRV Look up and SIP Server Fail Over,</p> <p>Support customizable idle screen via downloading XML by HTTP/TFTP</p>					
<b>Security</b>	<p>DIGEST authentication and encryption using MD5 and MD5-sess, SRTP, SIP over TLS (pending)</p>					

## Using the GXP SIP Enterprise Phone

### GETTING FAMILIAR WITH THE LCD





GXP-2xxx has a dynamic and customizable screen. The screen displays differently depending on whether the phone is idle or in use (active screen).



**Table 8: LCD Buttons**

Key Button	Key Button Definitions
<b>LINE SELECTOR S</b>	Selects the phone line printed on its right-hand side.
<b>SIP PHONE LINES</b>	Displays the available phone lines. Choose a phone line by pressing the corresponding line selector on the left-hand side.
<b>DATE AND TIME</b>	Displays the current date and time. Can be synchronized with Internet time servers.
<b>LOGO</b>	Displays company logo. This logo can be customized. For more information on customizing the logo, please check page 24.
<b>NETWORK STATUS</b>	Shows the status of the phone and network. It will indicate whether the network is down, starting or is running (show IP-number). Other messages such as "DO NOT DISTURB" or "## MISSED CALLS" are shown here too.
<b>STATUS BAR</b>	Shows the status of the phone, using icons as shown in the next table.
<b>LINE STATUS INDICATOR</b>	Displays the name of the account that is in use. Select another account by pressing the LINE SELECTOR BUTTONS
<b>SOFT-BUTTONS (Excluding GXP-2000)</b>	<p>The soft-buttons are context sensitive and will change depending on the status of the phone. Typical functions assigned to soft-buttons are:</p> <ul style="list-style-type: none"> <li>• <b>NEW CALL</b> Press this button to make a new hand-free call.</li> <li>• <b>FORWARD ALL</b> Unconditionally forwards the main phone line to another phone</li> <li>• <b>MISSED CALLS</b> This option shows up there were unanswered calls to this phone. The MissedCalls option shows a list of the missed calls</li> <li>• <b>CALL RETURN</b> Calls the phone that called/tried to call your phone last.</li> <li>• <b>REDIAL</b> Redials the last number</li> <li>• <b>END CALL</b> Hangs up phone</li> </ul>



<b>SPECIAL SOFT BUTTONS (Excluding GXP2000 and Only When Integrated with GXE5024/5028)</b>	<p><b>Call Parking:</b> FOR GXP2020/GXP2010 ONLY. Refer to the GXE5024/5028 Online User Manual for more information.</p> <ul style="list-style-type: none"> <li> <b>CallPark</b> When a GXP2020 dials out, the Call Park soft button will display on screen. To park the call, press the 'Call Park' button.         </li> <li> <b>PickUp</b> When another GXP2020 goes off-hook the Call Pickup soft button will display on screen. To pickup the parked call, press the 'Call Pickup' button.         </li> </ul>
	<p><b>Call Queue:</b> FOR GXP2020/2010 and 1200 only. Refer to the GXE5024/5028 Online User Manual for more information.</p> <ul style="list-style-type: none"> <li> <b>SignIn</b> Press this button to sign in to the call queue. Agent will be prompted in the LCD display to select the call queue to join. Press 'menu' button on keypad to select 'ok'. Once the agent completely signs in, the agent will be brought back to the main screen.         </li> <li> <b>SignOut</b> Press this button to sign out of the call queue. Press 'menu' button on keypad to select 'ok'. This will be displayed once the agent is signed in to the call queue.         </li> </ul> <p><b>PUBLIC MODE</b> (Also mentioned on p.31 of this manual): This useful mode complements the Call Queue feature by allowing various user agents to log in/log off, sharing the same phone. When enabled, all other accounts on the phone will not be active. For more information, refer to <a href="http://www.grandstream.com/support/gxe_series/gxe502x/documents/gxe502X_call_queue_with_gxp.pdf">http://www.grandstream.com/support/gxe_series/gxe502x/documents/gxe502X_call_queue_with_gxp.pdf</a></p> <ul style="list-style-type: none"> <li> <b>LogIn</b> Press this button to log in the user agent into the call queue.         </li> <li> <b>Tab</b> Press this button to jump to toggle between UserName and Password entry fields.         </li> <li> <b>Backspace</b> Press this button to erase the previously typed digit, letter, or character.         </li> <li> <b>LogOut</b> Press this button to log out the user agent out of the call queue.         </li> </ul>

**Table 9: LCD Icons**

Icon	LCD Icon Definitions
	<p><b>Connectivity Status / SIP Proxy/Server Icon:</b>  <b>Solid</b> – connected to SIP Server/IP address received  <b>Blinking</b> – physical connection failed  <b>Blank</b> – SIP Proxy/Server not registered</p>
	<p><b>Phone Status Icon:</b>  OFF when the handset is on-hook  ON when the handset is off-hook</p>
	<p><b>Speaker Phone Status Icon:</b>  FLASH when phone rings or a call is pending  OFF when the speakerphone is off  ON when the speakerphone is on</p>
	<p><b>DND Icon:</b>  ON when the "do not disturb" is activated  Activate by pressing MUTE/DEL button once</p>

	<p><b>Calls Forwarded Icon:</b> INDICATES calls are forwarded Follow 'call forwarding' procedures</p>
	<p><b>Handset, Speakerphone and Ring Volume Icon:</b> Each icon appears next to the volume icon To adjust volume, use the up/down button</p>
	<p><b>Real-time Clock:</b> Synchronized to Internet time server Time zone configurable via web browser AM/PM indicator</p>

**TABLE 10: GXP KEYPAD BUTTONS**

Key Button	Key Button Definitions
<b>LINE BUTTONS</b>	Line keys with LED, can be configured to different SIP profiles
<b>TRANSFER</b>	TRANSFER key: Transfer an ACTIVE call to another number
<b>CONF</b>	Press CONF button to connect Calling/Called party into conference
<b>MUTE</b>	Mute an active call; or Delete a key entry Also used to 'REJECT' incoming call.
<b>HOLD</b>	Place ACTIVE call on hold
<b>MSG</b>	Enter to retrieve voice mails or other messages
	Enable/Disable hands-free speaker mode
<b>SEND</b>	Press SEND to dial a new number or redial the last number dialed. Press send button to send a call immediately before "no key entry timeout" value expires
	Enter to retrieve voice mails or other messages
<b>MENU</b>	Enter Keypad Configuration "MENU" mode when phone is in IDLE mode. Use as ENTER key when in Keypad Configuration.
<b>0 - 9, *, #</b>	Standard phone keypad; press # key to send call; press * key to for IVR functions
<b>DND</b>	DO NOT DISTURB key; Press DND to turn "Do not disturb" function on or off.
<b>HEADSET</b>	Press HEADSET key to answer/hang up phone calls while using headset. It also allows user to toggle between headset and speaker. Not available on GXP2000.
<b>INTERCOM</b>	Turn intercom function on/off
	Brings phonebook on screen

## MAKING PHONE CALLS

### Handset, Speakerphone and Headset Mode

The GXP series phones allow you make phone calls via handset, speakerphone, or headset mode. During the active calls the user can switch between the handset and the speaker by pressing the speaker key. For headsets to operate, the user must plug the headset to an RJ22 or 2.5mm port on the phone, which allows the user to pick-up, speak, or hang-up calls.

### Multiple SIP Accounts and Lines

GXP can support up to six independent SIP accounts depending on the product model. Each account is capable of independent SIP server, user and NAT settings. Each of the line buttons is “virtually” mapped to an individual SIP account. The name of each account is conveniently printed next to its corresponding button. In off-hook state, select an idle line and the name of the account (as configured in the web interface) is displayed on the LCD and a dial tone is heard.

*For example:* Configure ACCOUNT 1 and ACCOUNT 2 with Account Name as “VoIP 1”, “VoIP 2”, respectively and ensure that they are active and registered. When LINE1 is pressed, you will hear a dial tone and see “VoIP 1” on the LCD display; when LINE2 is pressed, you will hear a dial tone and see “VoIP 2” on the LCD display.

To make a call, select the line you wish to use. The corresponding LINE LED will light up in green. User can switch lines before dialing any number by pressing the same LINE button one or more times. If you continue to press a LINE button, the selected account will circulate among the registered accounts.

**For example:** when LINE1 is pressed, the LCD displays “VoIP 1”; If LINE1 is pressed twice, the LCD displays “VoIP 2” and the subsequent call will be made through SIP account 2.

Incoming calls to a specific account will attempt to use its corresponding LINE if it is not in use. When the “virtually” mapped line is in use, the GXP will flash the next available LINE (from left to right or from top to bottom for Multi Purpose Keys) in red. A line is ACTIVE when it is in use and the corresponding LED is red.

### Completing Calls

There are six ways to complete a call:

1. **DIAL:** To make a phone call.
  - Take Handset/SPEAKER/Headset off-hook or press an available LINE key (activates speakerphone) or press the NEW CALL soft-key.
  - The line will have a dial tone and the primary line (LINE1) LED is red. If you wish, select another LINE key (alternative SIP account).
  - Enter the phone number
  - Press the SEND key or press the “DIAL” soft-key.
2. **REDIAL:** To redial the last dialed phone number.

When redialing the phone will use the same SIP account as was used for the last call. Thus, when the third SIP account was made for the last call/call attempt, the phone will use the third account to redial.

  - Take Handset/SPEAKER/Headset off-hook or press an available LINE key (activates speakerphone), the corresponding LED will be red.
  - Press the SEND button or press the REDIAL soft-key.



3. **CALL RETURN:** To call the last phone number that called your phone.  
When returning a call, the phone will use the same SIP account as the call was made to. Thus, when returning a call made to the third SIP account, the phone will use the third SIP account return the call.
  - i. Hand-free option
    1. Press the CALL RETURN soft-key
  - ii. Hand-set option
    1. Take the Handset off-hook
    2. Press the CALL RETURN soft-key
  
4. **USING THE CALL HISTORY:** To call a phone number in the phone's history  
When using the call history, the phone will use the same SIP account as was used for the last call/call attempt. Thus, when returning a call made to the third SIP account, the phone will use the third SIP account return the call.
  - Press the MENU button to bring up the Main Menu.
  - Select Call History and then "Received Calls", "Missed Calls" or "Dialed Calls" depending on your needs
  - Select phone number using the arrow keys
  - Press OK to select
  - Press OK again to dial.
  
5. **USING THE PHONEBOOK:** Calling a phone in from the phone's phonebook.  
Each entry in the phonebook can be attached to an individual SIP account. The phone will use that SIP account to make the phone call.
  - Go to the phonebook by:
    - i. Pressing the phonebook button (bottom, left-hand side of phone), or
    - ii. Pressing the DOWN arrow key, or
    - iii. Pressing the menu button and  
Selecting "Phone book" and  
Press MENU
  - Select the phone number by using the arrow keys
  - Press OK so select
  - Press OK again to dial.
  
6. **PAGING/INTERCOM:**  
The paging/intercom function can only be used if the SERVER/PBX supports this feature and both the phones and PBX are correctly configured.
  - Take the Handset/SPEAKER/Headset off-hook,
  - Select the LINE key associated with account
  - Press OK key to display LCD: **LINEx: PAGE USING.**
  - Dial the phone number you want to Page/Intercom
  - Press SEND key.

**NOTE:** Dial-tone and dialed number display occurs after the handset is off-hook and the line key is selected. The phone waits 4 seconds (by default; No key Entry Timeout) before sending and initiating the call. Press the "SEND" or "#" button to override the 4 second delay.

## Speed Dial

The Multi Purpose Key buttons, located on the right-hand-side of the phone, can be configured for speed dial. Press the speed dial button to automatically call the assigned extension.

**Note:** The multi-functional buttons will function as LINE keys when all LINEs are busy. The LED will flash in red to indicate an incoming call. Press the button to pick up the call. If any one of the Multi Purpose Keys is associated with a call, the button's speed dial/BLF function will not work.

## Making Calls using IP Addresses

Direct IP calling allows two phones to talk to each other in an ad hoc fashion without a SIP proxy. VoIP calls can be made between two phones if:

- Both phones have public IP addresses, or
- Both phones are on a same LAN/VPN using private or public IP addresses, or
- Both phones can be connected through a router using public or private IP addresses (with necessary port forwarding or DMZ)

To make a direct IP call, please follow these steps:

1. Press MENU button to bring up MAIN MENU.
2. Select "Direct IP Call" using the arrow-keys.
3. Press OK to select.
4. Input the 12-digit target IP address. (Please see example below).
5. Press OK key to initiate call.

To make a quick IP call, please see next section.

**For example:** If the target IP address is 192.168.1.60 and the port is 5062 (e.g. 192.168.1.60:5062), input the following: **192\*168\*1\*60#5062** - The "\*" key represent the dot "." ; The "#" key represent colon ":". Press OK to dial out.

## Quick IP Call Mode

The GXP also supports Quick IP call mode. This enables the phone to make direct IP-calls, using only the last few digits (last octet) of the target phone's IP-number.

This is possible only if both phones are in under the same LAN/VPN. This simulates a PBX function using the CMSA/CD without a SIP server. Controlled static IP usage is recommended.

## Setting up the phone to make Quick IP calls

To enable Quick IP calls, the phone has to be setup first. This is done through the web-setup function. In the "Advanced Settings" page, set the "Use Quick IP-call mode to YES. When #xxx is dialed, where x is 0-9 and xxx <=255, a direct IP call to aaa.bbb.ccc.XXX is completed. "aaa.bbb.ccc" is from the local IP address regardless of subnet mask. The numbers #xx or #x are also valid. The leading 0 is not required (but OK).

**For example:**

- 192.168.0.2 calling 192.168.0.3 -- dial #3 follow by SEND or #
- 192.168.0.2 calling 192.168.0.23 -- dial #23 follow by SEND or #
- 192.168.0.2 calling 192.168.0.123 -- dial #123 follow by SEND or #
- 192.168.0.2: dial #3 and #03 and #003 results in the same call -- call 192.168.0.3

**NOTE:** If you have a SIP Server configured, a Direct IP-IP still works. If you are using STUN, the Direct IP-IP call will also use STUN. Configure the "Use Random Port" to "NO" when completing Direct IP calls.

## ANSWERING PHONE CALLS

### Receiving Calls

1. **Incoming single call:** Phone rings with selected ring-tone. The corresponding account LINE flashes red. Answer call by taking Handset/SPEAKER/Headset off hook or pressing SPEAKER or by pressing the corresponding account LINE button.
2. **Incoming multiple calls:** When another call comes in while having an active call, the phone will produce a Call Waiting tone (stutter tone). Next available lines will flash red (as described in section 4.3.2). Answer the incoming call by pressing its corresponding LINE button. The current active call will be put on hold.
3. **Paging/Intercom Enabled:** Phone beeps once and automatically establishes the call via SPEAKER. (PBX (or Server) must also supports this feature)

### Do Not Disturb

1. Press the “DND” or “MUTE” button if you do not want to take a call. This will send the caller directly to voicemail.
2. Press the “DND” or “MUTE” button to set phone to ‘do not disturb’ (icon will be on the screen). The phone will not ring and send caller directly to voicemail. (see note above)

## PHONE FUNCTIONS DURING A PHONE CALL

### Call Waiting/ Call Hold

1. **Hold:** Place a call on ‘hold’ by pressing the “HOLD” button.
2. **Resume:** Resume call by pressing the corresponding blinking LINE.
3. **Multiple Calls:** Automatically place ACTIVE call on ‘HOLD’ by selecting another available LINE to place or receive another call. Call Waiting tone (stutter tone) audible when line is in use.

### Mute/Delete

1. Press the MUTE button to enable/disable muting the microphone.
2. The “Line Status Indicator” will show “LINEx: SPEAKING” or “LINEx: MUTE” to indicate whether the microphone is muted.

**NOTE:** Pressing MUTE button for an incoming call will reject the call. MUTE button also functions as delete key when user wishes to delete the last entered digit.

### Call Transfer

GXP supports both *Blind* and *Attended* (or supervised) transfer:

1. **Blind Transfer:** Press “TRANSFER (or TRNF for GXP-2000)” button, then dial the number and press the “SEND” button to complete transfer of active call.
2. **Attended (or Supervised) Transfer:** Press “LINEx” button to make a call and automatically place the ACTIVE LINE on HOLD. Once the call is established, press “TRANSFER (or TRNF)” key then

the LINE button of the waiting line to transfer the call. Hang up the phone call after “Transfer Successful” is displayed in the screen.

**NOTE:** To transfer calls across SIP domains, SIP service providers must support transfer across SIP domains. Blind transfer will usually use the primary account SIP profile.

## 5-Way Conferencing

GXP can host conference calls and supports up to 5-way conference calling.

### 1. Initiate a Conference Call:

- Establish a connection with two or more parties
- Press CONF button
- Choose the desired line to join the conference by pressing the corresponding LINE button.
- Repeat previous two steps for all other parties that would like to join the conference. This can be done at any time. However, if a new call comes in, the other calls will be placed on hold and the host will have to individually re-join the held lines back into the conference by repeating the previous two steps again.

### 2. Cancel Conference: Canceling establishing conference call.

- If after pressing the “CONF” button, a user decides not to conference anyone, press CONF again or the original LINE button.
- This will resume two-way conversation.

### 3. End Conference:

- Press HOLD to end the conference call and put all parties on hold;
- To speak with an individual party, select the corresponding blinking LINE.

NOTE: The party that starts the conference call has to remain in the conference for its entire duration, you can put the party on mute but it must remain in the conversation.

## Voice Messages (Message Waiting Indicator)

A blinking red MWI (Message Waiting Indicator) indicates a message is waiting. Press the MSG button to retrieve the message. An IVR will prompt the user through the process of message retrieval. Press a specific LINE to retrieve messages for a specific line account.

### NOTE:

- Each line has a separate voicemail account. Each account requires a voicemail portal number to be configured in the “voicemail user id” field.
- To check which line account has a message 1) press the message button (this always checks the primary account), 2) check each line for stutter tone or 3) check missed calls using the menu.

## Busy Lamp Field

The Multi Purpose Key buttons can be configured for Busy Lamp Field function with a specified account. When BLF is configured on one of the multi-functional buttons, the Speed Dial function will work when that line is not in use. Call Pick Up is supported when user presses a flashing BLF key.

## CALL FEATURES

The GXP supports traditional and advanced telephony features including caller ID, caller ID w/name, call forward/transfer/park/hold as well as intercom/paging and BLF.

**Table 11: GXP Call Features**

Key	Call Features
*30	<b>Block Caller ID</b> (for all subsequent calls)
*31	<b>Send Caller ID</b> (for all subsequent calls)
*67	<b>Block Caller ID</b> (per call)
*82	<b>Send Caller ID</b> (per call)
*50	<b>Disable Call Waiting</b> (for all subsequent calls)
*51	<b>Enable Call Waiting</b> (for all subsequent calls)
*70	<b>Disable Call Waiting</b> (per Call)
*71	<b>Enable Call Waiting</b> (per Call)
*72	<b>Unconditional Call Forward</b> Dial “*72” for a dial tone. Dial the forwarding number followed by “#”. Wait for dial tone. LCD will display “Call FWD Activated”.
*73	<b>Cancel Unconditional Call Forward:</b> dial “*73” and get the dial tone, then hang up. LCD will display “Call FWD Activated”.
*90	<b>Busy Call Forward</b> Dial “*90” for a dial tone. Dial the forwarding number followed by “#”. Wait for a dial tone. Hang up.
*91	<b>Cancel Busy Call Forward:</b> dial “*91”. Wait for dial tone. Hang up.
*92	<b>Delayed Call Forward</b> Dial “*92” for a dial tone. Dial the forwarding number followed by “#”. Wait for a dial tone. Hang up. LCD will display “Call FWD Activated”.
*93	<b>Cancel Delayed Call Forward</b> Dial “*93” for a dial tone, then hang up.

## CUSTOMIZED LCD SCREEN & XML

Grandstream GXP Series phones support both simple and advanced XML applications: 1) XML Custom Screen, 2) XML Downloadable Phonebook and 3) Advanced XML Survey Application. For more information on how to create a downloadable XML phonebook, creating a custom idle screen and/or reprogramming the soft-keys on GXP-1200/GXP-2010/GXP2020, please visit our website at: [http://www.grandstream.com/support/gxp\\_series/general/gxp\\_support.html](http://www.grandstream.com/support/gxp_series/general/gxp_support.html) .

## Configuration Guide

The GXP can be configured in two ways. Firstly, using the Key Pad Configuration Menu on the phone; secondly, through embedded web-configuration menu.

### CONFIGURATION VIA KEYPAD

To enter the MENU, press the round button. Navigate the menu by using the arrow keys: up/down and left/right. Press the OK button to confirm a menu selection, delete an entry by pressing the MUTE/DEL button. The phone automatically exits MENU mode with an incoming call, the phone is off-hook or the MENU mode if left idle for 20 seconds.

Press the MENU button to enter the key the Key Pad Menu. The menu options available are listed in table 8.

**Table 12: Key Pad Configuration Menu**

<b>Call History</b>	Displays histories of incoming, dialed and missed calls.
<b>Status</b>	Displays the network status, account statuses, software version and MAC-address of the phone.
<b>Phone Book</b>	Displays the phonebook
<b>LDAP Directory</b>	Displays the LDAP directory
<b>Instant Messages</b>	Goes to voice messages
<b>Direct IP call</b>	Displays the IP-call options menu
<b>Preference</b>	<p>Press <i>Menu</i> button to enter this sub menu including</p> <ul style="list-style-type: none"> <li>• <b>“Do NOT Disturb”</b> DND (Do NOT Disturb) function could be turned on or off in the “DO NOT Disturb” menu.</li> <li>• <b>Ring Tone</b> Choose different ring tones in the “Ring Tone” menu.</li> <li>• <b>Ring Volume</b> Press <i>Menu</i> button to hear the selected ring volume, press ‘←’ or ‘→’ to hear and adjust the ring tone volume.</li> <li>• <b>LCD Contrast</b></li> <li>• <b>LCD Brightness</b></li> <li>• <b>Download SCR XML</b> The phone will download the custom idle screen (if available)</li> <li>• <b>Erase Custom SCR</b> Custom idle screen will be erased and will be replaced with default Grandstream logo.</li> <li>• <b>Display Language</b> You can choose English, Chinese or Secondary Language</li> </ul> <p>Press <i>Menu</i> button to choose the menu item. Press ‘←’ to return to the main menu.</p>

<b>Configure</b>	<p>Press <i>Menu</i> button to display the configuration selections:</p> <ul style="list-style-type: none"> <li>• <b>Network.</b> To enable/disable DHCP. To setup IP-address, Net mask and Gateway address</li> <li>• <b>SIP</b> To change SIP-server settings for primary account.</li> <li>• <b>Upgrade</b> In this menu setting regarding the firmware server and Config server can be changed. It also enables the user to make the phone attempt to download new firmware.</li> <li>• <b>Factory Reset</b> Key in the physical/MAC address on back of the phone. Press <i>Menu</i> button to reset FACTORY DEFAULT setting. Do not use Factory Reset unless you want to restore factory settings</li> <li>• <b>Layer 2 QoS</b> Configure Vlan Tags</li> </ul> <p>Press ‘←’ to return the main menu.</p>
<b>Factory Functions</b>	<p>Press <i>Menu</i> to display the factory function items including</p> <ul style="list-style-type: none"> <li>• <b>Audio Loopback</b> Speak into the handset. If you hear your voice in the handset, your audio works fine. Press <i>Menu</i> button to exit the mode.</li> <li>• <b>Diagnostic Mode</b> All LEDs will light up Press any key on the keypad, to display the button name in the LCD. Lift and put back the handset or press <i>Menu</i> button to exit the diagnostic mode.</li> <li>• <b>Enable WDT</b> Toggles the status of the Watchdog Timer.</li> </ul> <p>Press ‘←’ to return to the main menu.</p>
<b>Reboot</b>	<p>Press <i>Menu</i> button to reboot the device Display “Exit” Press <i>Menu</i> button to exit the menu</p>
<b>Exit</b>	<p>Exit from this menu.</p>

**FIGURE 3: KEYPAD GUI FLOW**

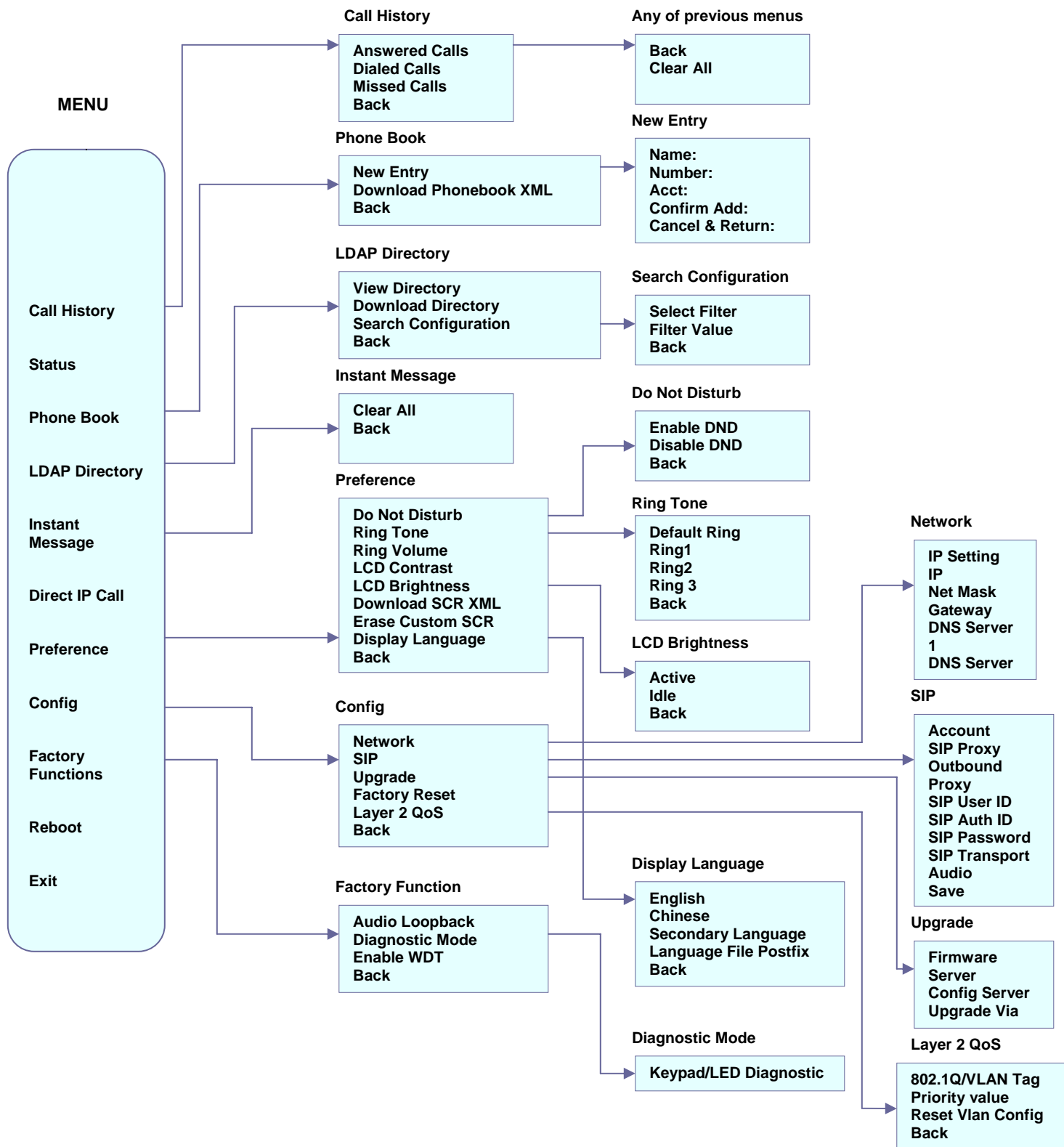



## CONFIGURATION VIA WEB BROWSER

The GXP embedded Web server responds to HTTP/HTTPS GET/POST requests. Embedded HTML pages allow a user to configure the IP phone through a Web browser such as Microsoft's IE or Mozilla Firefox.

### Access the Web Configuration Menu

To access the phone's Web Configuration Menu

- Connect the computer to the same network as the phone<sup>1</sup>
- Make sure the phone is turned on and shows its IP-address
- Start a Web-browser on your computer
- Enter the phone's IP-address in the address bar of the browser<sup>2</sup>
- Enter the administrator's password to access the Web Configuration Menu<sup>3</sup>

<sup>1</sup> The Web-enabled computer has to be connected to the same sub-network as the phone. This can easily be done by connecting the computer to the same hub or switch as the phone is connected to. In absence of a hub/switch (or free ports on the hub/switch), please connect the computer directly to the phone using the PC-port on the phone.

<sup>2</sup> If the phone is properly connected to a working Internet connection, the phone will display its IP address. This address has the format: xxx.xxx.xxx.xxx, where xxx stands for a number from 0-255. You will need this number to access the Web Configuration Menu. **e.g.** if the phone shows 192.168.0.60, please use "*http://192.168.0.60*" in the address bar your browser.

<sup>3</sup> The default administrator password is "**admin**"; the default end-user password is "**123**".

**NOTE:** When changing any settings, always SUBMIT them by pressing the button on the bottom of the page. Reboot the phone to have the changes take effect. If, after having submitted some changes, more settings have to be changed, press the menu option needed.

### Definitions

This section will describe the options in the Web configuration user interface. As mentioned, a user can log in as an administrator or end-user.

Functions available for the end-user are:

- **Status:** Displays the network status, account statuses, software version and MAC-address of the phone
- **Basic:** Basic preferences such as date and time settings, multi-purpose keys and LCD settings can be set here.

Additional functions available to administrators are:

- **Advanced Settings:** To set advanced network settings, codec settings and XML configuration settings.
- **Account X:** To configure each of the SIP accounts.
- **EXT X:** To configure setting on extension module

**Table 13: Device Configuration - Status**

<b>MAC Address</b>	The device ID, in HEXADECIMAL format.
<b>IP Address</b>	This field shows IP address of GXP
<b>Product Model</b>	This field contains the product model information.
<b>Part Number</b>	This field contains the product part number
<b>Software Version</b>	<ul style="list-style-type: none"> <li>• <b>Program:</b> This is the main software (firmware) release number, always used to identify the software (firmware) system of the phone.</li> <li>• <b>Boot:</b> Booting code version number</li> </ul>
<b>System Up Time</b>	This field shows system up time since the last reboot.
<b>System Time</b>	This field shows the current time on the phone system.
<b>Registered</b>	Indicates whether accounts are registered to the related SIP server(s). GXP can support four unique SIP profiles.
<b>PPPoE Link Up</b>	Indicates whether the PPPoE connection is enabled (connected to a modem).

**Table 14: Device Configuration – Basic Settings**

<b>End User Password</b>	This contains the password to access the Web Configuration Menu. This field is <u>case sensitive</u> with a maximum length of 25 characters.
<b>IP Address</b>	<p>There GXP operates in two modes:</p> <ol style="list-style-type: none"> <li>1. <b>DHCP mode:</b> all the field values for the Static IP mode are not used (even though they are still saved in the Flash memory.) The GXP acquires its IP address from the first DHCP server it discovers on its LAN. The DHCP option is reserved for NAT router mode. To use the PPPoE feature, set the PPPoE account settings. The GXP establishes a PPPoE session if any of the PPPoE fields is set.</li> <li>2. <b>Static IP mode:</b> configure all of the following fields: IP address, Subnet Mask, Default Router IP address, DNS Server 1 (primary), DNS Server 2 (secondary). These fields are set to zero by default.</li> </ol>
<b>Multi Purpose Key X</b>	<p>These options are used to assign a function to the corresponding multi purpose key. Options available are:</p> <ol style="list-style-type: none"> <li>1. “Speed Dial”.</li> <li>2. “BLF” (Busy Lamp Field). This option has to be supported on the PBX and it indicates the status of the extension. The three possible states are idle (green), busy (red), ringing (blinking red).</li> <li>3. “Presence Watcher”. This option has to be supported by a presence server and it is tied to the “Do not disturb” status of the phone.</li> <li>4. “Eventlist BLF”. This option is similar to the BLF option but in this case the PBX collects the information from the phones and sends it out in one single notify message.</li> </ol> <p>Each function is connected to one of the accounts and has a target user ID.</p>
<b>Time Zone</b>	This parameter controls the date/time display according to the specified time zone.

<b>LCD Backlight Always On</b>	Turn on LCD backlight at all times. Default is No. This option applies to GXP-1200/GXP-2000 only.
<b>Time Display Format</b>	LCD time display in 12 hour or 24 hour format
<b>Date Display Format</b>	Choose one of the following formats: <ul style="list-style-type: none"> <li>• Year-Month-Day</li> <li>• Month-Day-Year</li> <li>• Day-Month-Year</li> </ul> <p>This option applies to GXP280/GXP-1200/GXP-2000 only.</p>
<b>Display Clock instead of Date</b>	Choose to display clock or date on LCD. This option applies to GXP-280/GXP-1200/GXP-2000 only.
<b>Daylight Savings Time</b>	<p>This parameter controls time displayed in daylight savings time. If set to “Yes”, then the displayed time will be 1 hour ahead of normal time.</p> <p>The “Optional Rule” is configured to automatically adjust the Daylight Savings Time (DST) based on the rule set in this field.</p> <p><b>Rule Syntax:</b></p> <ul style="list-style-type: none"> <li>• start-time; end-time; saving</li> <li>• Both start-time and end-time have the same syntax: month,day,weekday,hour,minute <ul style="list-style-type: none"> <li>○ month: 1,2,3,...,12 (for Jan, Feb, ..., Dec)</li> <li>○ day: [+ -]1,2,3,...,31</li> <li>○ weekday: 1, 2, 3, ..., 7 (for Mon, Tue, ..., Sun), or 0 which means the daylight saving rule is not based on week days but based on the day of the month.</li> <li>○ hour: hour (0-23), minute: minute (0-59)</li> </ul> </li> </ul> <p>If “weekday” is 0, it means the date to start or end daylight saving is at exactly the given date. In that case, the “day” value must not be negative. If “weekday” is not zero and “day” is positive, then the daylight saving starts on the first “day” the iteration of the weekday (e.g.: 1st Sunday, 3rd Tuesday etc). If “weekday” is not zero and “day” is negative, then the daylight saving starts on the last “day” the iteration of the weekday (e.g.: last Sunday, 3rd last Tuesday etc).</p> <p>The saving is in the unit of minutes. The saving time may also be preceded by a negative (-) sign if subtraction is desired instead of addition.</p> <p>The <b>default value</b> is set for US, the “Automatic Daylight Saving Time Rule” shall be set to “3,2,7,2,0;11,1,7,2,0;60”</p> <p><u>Examples</u>  US/Canada where daylight saving time is applicable:  03,02,7,02,00;11,1,7,02,00;60  This means the daylight saving time starts from the second Sunday of March at 2AM and ends the first Sunday of November at 2AM. The saving is 60 minutes.</p>
<b>LCD Backlight Brightness</b>	Set the LCD brightness level. Range from 0 to 8 where 0 means off and 8 means the brightest. For GXP2010 and GXP2020 only.
<b>LCD Contrast</b>	Set LCD contrast. Range from 0 to 20. Not for GXP280
<b>Disable in-call DTMF display</b>	Default is No. This field is used to hide the keypad input during a call.
<b>Mute Speaker Ringer</b>	Default is No. When it’s enabled, speaker won’t ring on an incoming call.

<b>Disable Missed Call Backlight</b>	Default is No. By default, LCD backlight will lit whenever there is a missed call. Not for GXP280.
<b>HEADSET Key Mode</b>	<p>Select either “Default mode” or “Toggle Headset/Speaker”.</p> <p>In “Default Mode”, only the speakerphone will ring for an incoming call. User can use the headset key to pick-up, speak, and hang up calls through headset. The headset icon will appear on the LCD when a call is in progress.</p> <p>If user wishes to ring the headset, “Toggle Headset/Speaker” option shall be checked. User will also need to press the HEADSET key while phone is idle. The headset icon will appear on the idle LCD screen.</p> <p>NOTE: This is not available for GXP2000</p>
<b>PC Port Mode</b>	For GXP1200/GXP280 only. Default is ‘Switch’. Choose to toggle between Switch/Hub mode.

Advanced User configuration includes not only the end user configuration, but also advanced configuration such as SIP configuration, Codec selection, NAT Traversal Setting and other miscellaneous configuration.

**Table 15: Advanced Settings**

<b>Admin Password</b>	Administrator password. Only the administrator can access the “Advanced Settings” and “Account Settings” page. Password field is purposely blank for security reasons after clicking update and saved. The maximum password length is 25 characters.
<b>G723 rate</b>	Encoding rate for G723 codec. By default, 6.3kbps rate is set.
<b>iLBC frame size</b>	iLBC packet frame size. Default is 20ms. For Asterisk PBX, 30ms might be required.
<b>iLBC payload type</b>	Payload type for iLBC. Default value is 97. The valid range is between 96 and 127.
<b>Silence Suppression</b>	This controls the silence suppression/VAD feature of the audio codec G.723 and G.729. If set to “Yes”, when silence is detected, a small quantity of VAD packets (instead of audio packets) will be sent during the period of no talking. If set to “No”, this feature is disabled.

<b>Voice Frames per TX</b>	<p>This field contains the number of voice frames to be transmitted in a single Ethernet packet (be advised the IS limit is based on the maximum size of Ethernet packet is 1500 byte (or 120kbps)).</p> <p>When setting this value, be aware of the requested packet time (ptime, used in SDP message) is a result of configuring this parameter. This parameter is associated with the <u>first</u> codec in the above codec Preference List or the actual used payload type negotiated between the 2 conversation parties at run time. <i>E.g.</i>, if the first codec is configured as G.723 and the “Voice Frames per TX” is set to 2, then the “ptime” value in the SDP message of an INVITE request will be <u>60ms</u> because each G.723 voice frame contains 30ms of audio. Similarly, if this field is set to 2 and the first codec is G.729 or G.711 or G.726, then the “ptime” value in the SDP message of an INVITE request will be <u>20ms</u>.</p> <p>If the configured voice frames per TX exceeds the maximum allowed value, the IP phone will use and save the maximum allowed value for the corresponding first codec choice. The maximum value for PCM is 10 (x10ms) frames; for G.726, it is 20 (x10ms) frames; for G.723, it is 32 (x30ms) frames; for G.729/G.728, 64 (x10ms) and 64 (x2.5ms) frames respectively.</p> <p>Please be careful when editing these parameters. Adjusting these parameters will also change the dynamic jitter buffer. The GXP has a patent dynamic jitter buffer handling algorithm. The jitter buffer range is 20 ~ 200 ms.</p> <p>Grandstream recommends using the default settings provided. Grandstream does not recommend adjusting these parameters if you are an average user. Incorrect settings will affect the voice quality. Please refer to the Codec FAQ at <a href="http://www.grandstream.com/pdf/FAQ-Codec.pdf">http://www.grandstream.com/pdf/FAQ-Codec.pdf</a> for more technical detail.</p>
<b>Layer 3 QoS</b>	<p>This field defines the layer 3 QoS parameter. It is the value used for IP Precedence or Diff-Serv or MPLS. Default value is 48.</p>
<b>Layer 2 QoS</b>	<p>This contains the value used for layer 2 VLAN tag. Default setting is blank.</p>
<b>Data VLAN Tag</b>	<p>Default is 0. Enabling the Data VLAN filtering will help reduce the load on the phone, but it isn’t necessary in most environments. This is primarily for VLAN filtering where tagged traffic will be forwarded to the DSP.</p>
<b>No Key Entry Timeout</b>	<p>Default is 4 seconds.</p>
<b>Use # as Dial Key</b>	<p>This parameter allows users to configure the “#” key as the “Send” (or “Dial”) key. If set to “Yes”, the “#” key will immediately send the call. In this case, this key is essentially equivalent to the “(Re)Dial” key. If set to “No”, the “#” key is included as part of the dial string.</p>
<b>Local RTP port</b>	<p>This parameter defines the local RTP-RTCP port pair used to listen and transmit. It is the base RTP port for channel 0. When configured, channel 0 will use this port _value for RTP and the port_value+1 for its RTCP; channel 1 will use port_value+2 for RTP and port_value+3 for its RTCP. The default value is 5004.</p>
<b>Use Random Port</b>	<p>This parameter, when set to “Yes”, will force random generation of both the local SIP and RTP ports. This is usually necessary when multiple GXPs are behind the same NAT. Default is No.</p>

<b>Keep-alive interval</b>	This parameter specifies how often the GXP sends a blank UDP packet to the SIP server in order to keep the “hole” on the NAT open. Default is 20 seconds.
<b>Use NAT IP</b>	NAT IP address used in SIP/SDP message. Default is blank.
<b>STUN Server</b>	IP address or Domain name of the STUN server. STUN resolution result will display in the STATUS page of the Web UI.
<b>Firmware Upgrade and Provisioning</b>	Default method is HTTP. Firmware upgrade may take up to 10 minutes depending on network environment. Do not interrupt the firmware upgrading process.
<b>Via TFTP Server</b>	<p>This is the IP address of the configured TFTP server. If selected and it is non-zero or not blank, the GXP will attempt to retrieve a new configuration file or new code image from the specified TFTP server at boot time. It will make up to 3 attempts before timeout and then it will start the boot process using the existing code image in the Flash memory. If a TFTP server is configured and a new code image is retrieved, the new downloaded image will be verified and then saved into the Flash memory.</p> <p><b>Note:</b> Grandstream strongly recommends that the user upgrade firmware locally in a LAN environment if using TFTP to upgrade. Please do NOT interrupt the TFTP upgrade process (especially the power supply) as this will damage the device.</p>
<b>Via HTTP Server</b>	<p>The HTTP server URL used for firmware upgrade and configuration via HTTP. For example: <a href="http://provisioning.mycompany.com:6688/Grandstream/1.2.2.19">http://provisioning.mycompany.com:6688/Grandstream/1.2.2.19</a>. Here “:6688” is the specific TCP port that the HTTP server is using; omit if using default port 80.</p> <p><b>Note:</b> If Auto Upgrade is set to No, GXP will only perform HTTP download once at boot up.</p>
<b>Config Server Path</b>	IP address or domain name of firmware server.
<b>Firmware File Prefix/Postfix</b>	Default is blank. If configured, GXP will request the firmware file with the prefix/postfix. This setting is useful for ITSPs. End user should keep it blank.
<b>Config File Prefix/Postfix</b>	Default is blank. End user should keep it blank.
<b>Allow DHCP Option 43 and Option 66 to override server</b>	Default is Yes. This allows device gets provisioned automatically.
<b>Authenticate Conf File</b>	Default is “No”. If set to “Yes”, configuration file would be authenticated before acceptance. End user should use default setting.
<b>Automatic Upgrade</b>	<p>This function is used by ITSP. End user should NOT touch these parameters.</p> <p>Default is No. Choose “Yes” to enable automatic HTTP upgrade and provisioning. In “Check for upgrade every” field, enter the number of minutes to check the HTTP server for firmware upgrade or configuration changes. When set to “No”, the phone will only perform HTTP upgrade and configuration check once at boot up.</p>

<b>LDAP Directory</b>	IP address or domain name of LDAP script server
<b>Phonebook XML</b>	Enable the XML phonebook via TFTP or HTTP. Define XML server path and download interval. When the user downloads the XML phone the manually entered or edited entries will not be deleted unless this option is selected to Yes.
<b>Idle Screen XML Download</b>	Enable XML Idle Screen download via TFTP or HTTP. Define XML server path.
<b>XML Application</b>	Enter server path for XML application. This option applies to GXP-2020 and GXP-2010 only.
<b>Offhook Auto Dial</b>	To configure a User ID/extension to dial automatically when the phone is taken offhook.
<b>DTMF Payload Type</b>	This parameter sets the payload type for DTMF using RFC2833. Default is <b>101</b> .
<b>Onhook Threshold</b>	It determines the time handset has to be down to be recognized it's onhook. Default is 800ms. For GXP280 only.
<b>Syslog Server</b>	The IP address or URL of System log server. This feature is especially useful for ITSPs.
<b>Syslog Level</b>	<p>Select the ATA to report the log level. Default is NONE. The level is one of DEBUG, INFO, WARNING or ERROR. Syslog messages are sent based on the following events:</p> <ul style="list-style-type: none"> <li>• product model/version on boot up (INFO level)</li> <li>• NAT related info (INFO level)</li> <li>• sent or received SIP message (DEBUG level)</li> <li>• SIP message summary (INFO level)</li> <li>• inbound and outbound calls (INFO level)</li> <li>• registration status change (INFO level)</li> <li>• negotiated codec (INFO level)</li> <li>• Ethernet link up (INFO level)</li> <li>• SLIC chip exception (WARNING and ERROR levels)</li> <li>• memory exception (ERROR level)</li> </ul> <p>The Syslog uses USER facility. In addition to standard Syslog payload, it contains the following components: <i>GS_LOG: [device MAC address][error code] error message</i>  <i>For example:</i> May 19 02:40:38 192.168.1.14 GS_LOG: [00:0b:82:00:a1:be][000]. Ethernet link is up.</p>
<b>NTP server</b>	This parameter defines the URI or IP address of the NTP (Network Time Protocol) server. It is used to display the current date/time.
<b>Public Mode</b>	Default is 'No' (standard mode). Supported only on GXP1200, GXP2010, and GXP2020. This feature is designed specifically to support the Call Queue feature implemented on Grandstream's GXE5024 or GXE5028. If set to 'Yes', this feature will allow other call queue agents to login/logout using their own login name and password on the same phone. When enabled, all other accounts will not be active.

<b>Distinctive Ring Tone</b>	Caller ID must be configured. Select a Distinctive Ring Tone 1 through 3 for a particular Caller ID. The GXP will ONLY use selected ring tones for particular Caller IDs. For all other calls, the GXP will use System Ring Tone. When selected and no Caller ID is configured, the selected ring tone will be used for all incoming calls.
<b>System Ring Tone</b>	System ring tone. Default is North American standard. Adjust system ring tone frequencies and cadences based on local telecom standard.
<b>Call Progress Tones</b>	Using these settings, users can configure ring or tone frequencies based on parameters from local telecom. By default, they are set to North American standard. Frequencies should be configured with known values to avoid uncomfortable high pitch sounds.  <b>Syntax:</b> f1=val,f2=val[,c=on1/off1[-on2/off2[-on3/off3]]]; (Frequencies are in Hz and cadence on and off are in 10ms) ON is the period of ringing (“On time” in ‘ms’) while OFF is the period of silence. In order to set a continuous ring, OFF should be zero. Otherwise it will ring ON ms and a pause of OFF ms and then repeat the pattern. Up to three cadences are supported.
<b>Intercom User ID:</b>	This field is used to configure the Intercom key in the phone. For GXP2010 and GXP2020 only If the phone is working with a GS GXE502X IP-PBX it can be configured in the following manner: <ul style="list-style-type: none"> <li>To page an extension : [intercom feature code]+[*]+[extension number]</li> <li>To page a group : [paging group feature code]+[*]+[group extension]</li> </ul>
<b>Disable Call Waiting</b>	Default is No. If set to Yes, the call waiting feature will be disabled.
<b>Disable Call Waiting Tone</b>	Default is No. If set to Yes, the call waiting tone will be disabled.
<b>Disable Direct IP Calls</b>	Default is No. If set to Yes, direct IP calls will be disabled
<b>Use Quick IP Call Mode</b>	Dial an IP address under the same LAN/VPN segment by entering the last octet in the IP address.  In the Advanced Settings page there is an option “Use Quick IP-call mode”. Default setting is No. When set to YES, and #XXX is dialed, where X is 0-9 and XXX <=255, phone will make direct IP call to aaa.bbb.ccc.XXX where aaa.bbb.ccc comes from the local IP address REGARDLESS of subnet mask.  #XX or #X are also valid so leading 0 is not required (but OK). See <b>Quick IP Call Mode</b> for details.
<b>Disable Conference</b>	Default is No. If set to Yes, conference will be disabled.
<b>Lock keypad update</b>	If set to “Yes”, the configuration changes via keypad are disabled.
<b>Enable MPK Sending DTMF</b>	Default is No. If set to “Yes”, Multi-Purpose keys can be sent as DTMF. For GXP2020/2010/2000.



<b>Disable DND</b>	Default is No. If set to “Yes”, the “DND” button on keypad will be disabled. For GXP2000, MUTE/DEL button functions as DND button when pressed while phone is idle.
<b>Disable Transfer</b>	Default is No. If set to Yes, transfer will be disabled.
<b>Disable Multicast Filter</b>	Default is No. If set to Yes, the phone will not filter out (discard) multicast packets.
<b>Enable Constraint Mode</b>	Default is No. If set to Yes, the phone will limit the end-user’s access to the configuration of the phone.
<b>Display CID instead of Name</b>	If set to “Yes”, CID will be displayed in the screen instead of Name. Default is “No”. For GXP280 only.
<b>Headset Port Type</b>	Select either 2.5mm or RJ22 headset ports to be adjusted.
<b>Headset TX gain (dB)</b>	Increases the selected headset’s (2.5mm or RJ22) TX gain by + or – 6dB. Default is 0dB
<b>Headset RX gain (dB)</b>	Increases the selected headset’s (2.5mm or RJ22) RX gain by + or – 6dB. Default is 0dB
<b>Display Language</b>	<p>Allows user to choose preferred display language in web UI and key pad UI.</p> <p>Language file postfix allows the language file to have different postfixes so the phone can request a particular file. It will append an underscore “_” plus the string in the language file postfix.</p> <p>The default language file name is “gxp.lpf”. If the field “Language File postfix “has “NL” string in it, then the phone will request “gxp_NL.lpf” instead of “gxp.lpf.”</p> <p>User can only load one secondary language. Supported Secondary language: Czech, Dutch, Estonian, French, German, Italian, Polish, Portuguese, Slovak, Slovenian and Spanish.</p> <p>How to set up Secondary Language: Note: This is similar to updating firmware in your local network environment. Please refer to <a href="http://www.grandstream.com/faqsfirmware.html#4">http://www.grandstream.com/faqsfirmware.html#4</a> for details.</p> <ol style="list-style-type: none"> <li>1. Download the language package from <a href="http://www.grandstream.com/firmware.html">http://www.grandstream.com/firmware.html</a></li> <li>2. Unzip the language package</li> <li>3. Open the desired language zip file</li> <li>4. Copy gxp.lpf to the firmware server directory using your local TFTP or HTTP server.</li> <li>5. Access the advanced settings of the Web GUI, set “Display Language” to “Secondary Language”</li> <li>6. Update and reboot the phone</li> </ol>

GXP has up to six line appearances, each with an independent SIP account. Each SIP account requires its own configuration page. Their configurations are identical.

**Table 16: SIP Account Settings**

<b>Account Active</b>	This field indicates whether the account is active. The default value for the primary account (Account 1) is Yes. The default value for the other two accounts is No.
<b>Account Name</b>	The name associated with each account - displayed on LCD.
<b>SIP Server</b>	SIP Server's IP address or Domain name provided by VoIP service provider.
<b>Outbound Proxy</b>	IP address or Domain name of Outbound Proxy, Media Gateway, or Session Border Controller. Used for firewall or NAT penetration in different network environment. If the system detects symmetric NAT, STUN will not work. ONLY outbound proxy can provide solution for symmetric NAT.
<b>SIP User ID</b>	User account information provided by VoIP service provider (ITSP); either an actual phone number or formatted like one.
<b>Authenticate ID</b>	SIP service subscriber's Authenticate ID used for authentication. It can be identical to or different from SIP User ID.
<b>Authenticate Password</b>	SIP service subscriber's account password for GXP to register to (SIP) servers of ITSP.
<b>Name</b>	SIP service subscriber's name that is used for Caller ID display.
<b>Use DNS SRV:</b>	Default is No. If set to "Yes", the client will use DNS SRV to look up server.
<b>User ID is Phone Number</b>	If the phone has an assigned PSTN telephone number, this field should be set to "Yes". Otherwise, set it to "No". If "Yes" is set, a "user=phone" parameter will be attached to the "From" header in SIP request
<b>SIP Registration</b>	This parameter controls sending REGISTER messages to the proxy server. The default setting is "Yes".
<b>Un-register on Reboot</b>	Default is No. If set to "Yes", the SIP user's registration information will be cleared on reboot.
<b>Register Expiration</b>	This parameter allows user to specify the time frequency (in minutes) that GXP refreshes its registration with the specified registrar. The default interval is 60 minutes. The maximum interval is 65,535 minutes (about 45 days).
<b>Local SIP Port</b>	This parameter defines the local SIP port used to listen and transmit. The default value for Account 1 is 5060. It is 5062, 5064, 5066 for Account 2, Account 3 and Account 4 respectively.
<b>SIP Registration Failure Retry Wait Time</b>	Retry registration if the process failed. Default is 20 seconds.
<b>SIP T1 Timeout</b>	RFC 3261 SIP T1 timer. Default is 1 second.
<b>SIP T2 Interval</b>	RFC 3261 SIP T2 timer. Default is 0.5 seconds.
<b>SIP Transport</b>	Choose SIP Transport between UDP and TCP. Default is UDP.
<b>Use RFC3581 Symmetric Routing</b>	Default No. When selected the phone will follow the routing procedures specified in RFC3581.

<b>NAT Traversal (STUN)</b>	This parameter activates the NAT traversal mechanism. If activated (by choosing “Yes”) and a STUN server is also specified, the phone performs according to the STUN client specification. Using this mode, the embedded STUN client detects if and what type of NAT/Firewall configuration is used. If the detected NAT is a Full Cone, Restricted Cone, or a Port-Restricted Cone, the phone will use its mapped public IP address and port in all of its SIP and SDP messages. If the NAT Traversal field is set to “Yes” with no specified STUN server, the GXP will periodically (every 20 seconds or so) send a blank UDP packet (with no payload data) to the SIP server to keep the “hole” on the NAT open.
<b>SUBSCRIBE for MWI:</b>	Default is No. When set to “Yes” a SUBSCRIBE for Message Waiting Indication will be sent periodically.
<b>SUBSCRIBE for Registration Event</b>	Default is No. This is mainly used for IMS purposes. When enabled, the terminals should store the Service-Route header values after successfully registered, and thereafter add a route header with the values stored in the Service-Route when initiating a request excluding REGISTER.
<b>PUBLISH for Presence</b>	Enable Presence feature.
<b>Proxy-Require</b>	SIP Extension to notify SIP server that the unit is behind the NAT/Firewall.
<b>Voice Mail UserID</b>	When configured, user can access messages by pressing “MSG” button. This ID is usually the VM portal access number.
<b>Send DTMF</b>	This parameter specifies the mechanism to transmit DTMF digit. There are 3 supported modes: in audio which means DTMF is combined in audio signal (not very reliable with low-bit-rate codec), via RTP (RFC2833), or via SIP INFO.
<b>Early Dial</b>	Default is No. Use only if proxy supports 484 responses.
<b>Dial Plan Prefix</b>	Sets the prefix added to each dialed number.
<b>BLF Call-pickup Prefix</b>	Default is “***”. This prefix is prepended when answering call with BLF key.
<b>Delayed Call Forward Wait Time</b>	Time waited before the call is forward to a number or VM. Default is 20 seconds.
<b>Enable Call Features</b>	Default is Yes. If set to “No”, Call transfer, Call Forwarding & Do-Not-Disturb are supported locally provided ITSP support those features. In addition, “ForwardAll” softkey will be hidden if call feature code is disabled for Account 1.
<b>Call Log</b>	User can choose to disable Call Log and what kind of calls to log.
<b>Session Expiration</b>	The SIP Session Timer extension enables SIP sessions to be periodically “refreshed” via a SIP request (UPDATE, or re-INVITE. Once the session interval expires, if there is no refresh via a UPDATE or re-INVITE message, the session is terminated.  Session Expiration is the time (in seconds) at which the session is considered timed out, provided no successful session refresh transaction occurs beforehand. The default value is 180 seconds.
<b>Min-SE</b>	Defines the minimum session expiration (in seconds). Default is <b>90 seconds</b> .

<b>Caller Request Timer</b>	If set to “Yes”, the phone will use session timer when it makes outbound calls if remote party supports session timer.
<b>Callee Request Timer</b>	If selecting “Yes”, the phone will use session timer when it receives inbound calls with session timer request.
<b>Force Timer</b>	If set to “Yes”, the phone will use session timer even if the remote party does not support this feature. If set to “No”, the session timer is enabled only when the remote party supports this feature. To turn off Session Timer, select “No” for Caller Request Timer, Callee Request Timer, and Force Timer.
<b>UAC Specify Refresher</b>	As a Caller, select UAC to use the phone as the refresher, or UAS to use the Callee or proxy server as the refresher.
<b>UAS Specify Refresher</b>	As a Callee, select UAC to use caller or proxy server as the refresher, or UAS to use the phone as the refresher.
<b>Force INVITE</b>	Session Timer can be refreshed using INVITE method or UPDATE method. Select “Yes” to use INVITE method to refresh the session timer.
<b>Enable 100rel</b>	PRACK (Provisional Acknowledgment) method enables reliability to SIP provisional responses (1xx series). This is required to support PSTN inter-networking..
<b>Account Ring Tone</b>	There are 4 uniquely defined ring tones: <ul style="list-style-type: none"> <li>• One (1) System Ring Tone: when selected, all calls will ring with system ring tone.</li> <li>• Three (3) Customer Ring Tones: when selected, incoming calls from designated account will play selected ring tone.</li> </ul>
<b>Ring Timeout</b>	Defines how long ring will ring when receiving a call. Default is 60 seconds.
<b>Send Anonymous</b>	If this parameter is set to “Yes”, the “From” header in outgoing INVITE message will be set to anonymous, essentially blocking the Caller ID from displaying.
<b>Anonymous Method</b>	Whether to use “< sip:anonymous@anonymous.invalid>” in the From Header or P-Asserted-Identity header.
<b>Anonymous Call Rejection</b>	Default is NO. If set to YES, anonymous call will be rejected
<b>Auto Answer</b>	Default is No. If set to “Yes”, GXP will automatically switch on speaker to answer the incoming call. Set to Intercom/Paging mode, it will answer the call based on the SIP info header from the server.
<b>Allow Auto Answer by Call-Info</b>	If the Call-Info header contains answer-after=0, the call be answered automatically (so called paging mode).
<b>Turn off speaker on remote disconnect</b>	When BYE is received, the phone will turn off its speaker automatically.
<b>Check SIP User ID for incoming INVITE</b>	Check the SIP User ID in Request URI. If they don’t match, the call will be rejected.
<b>Refer-To Use Target Contact</b>	Default is NO. If set to YES, then for Attended Transfer, the “Refer-To” header uses the transferred target’s Contact header information.

<b>Disable Multiple Media Attribute in SDP</b>	Default is No.
<b>Preferred Vocoder</b>	GXP supports up to 7 different Vocoder types including G.711(a/μ) (also known as PCMU/PCMA), GSM, G.723.1, G.729A/B, G.726-32, iLBC, G.722 (wide-band).  Configure Vocoders in a preference list that is included with the same preference order in SDP message. Enter the first Vocoder in this list by choosing the appropriate option in "Choice 1". Similarly, enter the last Vocoder in this list by choosing the appropriate option in "Choice 8".
<b>SRTP Mode</b>	Enable SRTP mode based on selection. Default is No.
<b>eventlist BLF URI</b>	If a server supports this feature, user needs to configure an "eventlist BLF" URI on the service side (i.e.: <a href="mailto:BLF1006@myserver.com">BLF1006@myserver.com</a> ) On the GXP, under Account page, fill in the ""eventlist BLF" field with the URI without the domain. (i.e.: BLF1006). Under Basic Settings, please select "eventlist BLF", choose account number, monitored number, etc.
<b>Special Feature</b>	Default is Standard. Choose the selection to meet special requirements from Soft Switch vendors.

## SAVING THE CONFIGURATION CHANGES

After the user makes a change to the configuration, press the "Update" button in the Configuration Menu. The web browser will then display a message window to confirm saved changes.

Grandstream recommends reboot or power cycle the IP phone after saving changes.

## REBOOTING THE PHONE REMOTELY

Press the "Reboot" button at the bottom of the configuration menu to reboot the phone remotely. The web browser will then display a message window to confirm that reboot is underway. Wait 30 seconds to log in again.

## Software Upgrade & Customization

Software (or firmware) upgrades are completed via either TFTP or HTTP. The corresponding configuration settings are in the ADVANCED SETTINGS configuration page.

### FIRMWARE UPGRADE THROUGH TFTP/HTTP

To upgrade via TFTP or HTTP, select TFTP or HTTP upgrade method. “Upgrade Server” needs to be set to a valid URL of a HTTP server. Server name can be in either FQDN or IP address format. Here are examples of some valid URLs.

- firmware.mycompany.com:6688/Grandstream/1.2.2.19
- 72.172.83.110

There are two ways to set up the Upgrade Server to upgrade firmware: via Key Pad Menu and Web Configuration Interface.

### Key Pad Menu

To configure the Upgrade Server via Key Pad Menu options, select “Config” from the Main Menu, then select “Upgrade”. Under this sub Menu, user can edit Upgrade Server in either an IP address format or FQDN format. Choose “Save and use TFTP” or “Save and use HTTP” to select upgrade method. Select “Reboot” from the Main Menu to reboot the phone.

### Web Configuration Interface

To configure the Upgrade Server via the Web configuration interface, open the web browser. Enter the GXP IP address. Enter the admin password to access the web configuration interface. In the ADVANCED SETTINGS page, enter the Upgrade Server’s IP address or FQDN in the “Firmware Server Path” field. Select TFTP or HTTP upgrade method. Update the change by clicking the “Update” button. “Reboot” or power cycle the phone to update the new firmware.

During this stage, the LCD will display the firmware file downloading process. If a firmware upgrade fails for any reason (e.g., TFTP/HTTP server is not responding, there are no code image files available for upgrade, or checksum test fails, etc), the phone will stop the upgrading process and re-boot using the existing firmware/software.

Firmware upgrades take around 60 seconds in a controlled LAN or 5-10 minutes over the Internet. Grandstream recommends completing firmware upgrades in a controlled LAN environment whenever possible.

### No Local TFTP/HTTP Server

For users who do not have a local TFTP/HTTP server, Grandstream provides a HTTP server on the public Internet for users to download the latest firmware upgrade automatically. Please check the Support/Download section of our website to obtain this HTTP server IP address: <http://www.grandstream.com/firmware.html> .

Alternatively, download and install a free TFTP or HTTP server to the LAN to perform firmware upgrades. A free Windows version TFTP server is available: <http://support.solarwinds.net/updates/New-customerFree.cfm>.

### Instructions for local TFTP Upgrade:

1. Unzip the file and put all of them under the root directory of the TFTP server.
2. The PC running the TFTP server and the GXP should be in the same LAN segment.
3. Go to File -> Configure -> Security to change the TFTP server's default setting from "Receive Only" to "Transmit Only" for the firmware upgrade.
4. Start the TFTP server, in the phone's web configuration page
5. Configure the Firmware Server Path with the IP address of the PC
6. Update the change and reboot the unit

User can also choose to download the free HTTP server from <http://httpd.apache.org/> or use Microsoft IIS web server.

#### NOTE:

- When GXP phone boots up, it will send TFTP or HTTP request to download configuration file "cfg000b82xxxxx", where "000b82xxxxx" is the MAC address of the GXP phone. This file is for provisioning purpose. For normal TFTP or HTTP firmware upgrades, the following error messages in a TFTP or HTTP server log can be ignored: *"TFTP Error from [IP ADDRESS] requesting cfg000b82023dd4 : File does not exist. Configuration File Download"*

### CONFIGURATION FILE DOWNLOAD

The GXP can be configured via Web Interface as well as via Configuration File through TFTP or HTTP. "Config Server Path" is the TFTP or HTTP server path for the configuration file. It needs to be set to a valid URL, either in FQDN or IP address format.

A configuration parameter is associated with each particular field in the web configuration page. A parameter consists of a Capital letter **P** and 2 to 4 digit numeric numbers. i.e., P2 is associated with "Admin Password" in the ADVANCED SETTINGS page. For a detailed parameter list, please refer to the corresponding configuration template of the firmware.

Once the GXP boots up (or re-booted), it will request a configuration file named "cfgxxxxxxxxxxx", where "xxxxxxxxxxx" is the MAC address of the device, i.e., "cfg000b820102ab". The configuration file name should be in lower cases.

### Managing Firmware and Configuration File Download

When "Automatic Upgrade" is set to "Yes", a Service Provider can use P193 (Auto Check Interval, in minutes, default and minimum is 60 minutes) to have the devices periodically check for upgrades at pre-scheduled time intervals. By defining different intervals in P193 for different devices, a Server Provider can manage and reduce the Firmware or Provisioning Server load at any given time.

## Restore Factory Default Setting

**WARNING:** Restoring the Factory Default Setting will **delete** all configuration information of the phone. Please **backup** or **print** all the settings before you restoring factory default settings. Grandstream is not responsible for restoring lost parameters and cannot connect your device to your VoIP service provider.

### INSTRUCTIONS FOR RESTORATION:

**Step 1:** Press “OK” button to bring up the keypad configuration menu, select “Config”, press “OK” to enter submenu, select “Factory Reset” (Please refer to Table 5-1 of keypad flow chart)

**Step 2:** Enter the MAC address printed on the bottom of the sticker. Please use the following mapping:

0-9: 0-9

A: 22 (press the “2” key twice, “A” will show on the LCD)

B: 222

C: 2222

D: 33 (press the “3” key twice, “D” will show on the LCD)

E: 333

F: 3333

**Example:** if the MAC address is 000**b**8200**e**395, it should be key in as “000**222**8200**333**395”.

**NOTE:** If there are digits like “22” in the MAC, you need to type “2” then press “->” right arrow key to move the cursor or wait for 4 seconds to continue to key in another “2”.

**Step 3:** Press the “OK” button to move the cursor to “OK”. Press “OK” button again to confirm. If the MAC address is correct, the phone will reboot. Otherwise, it will exit to previous keypad menu interface.